

BOX 2

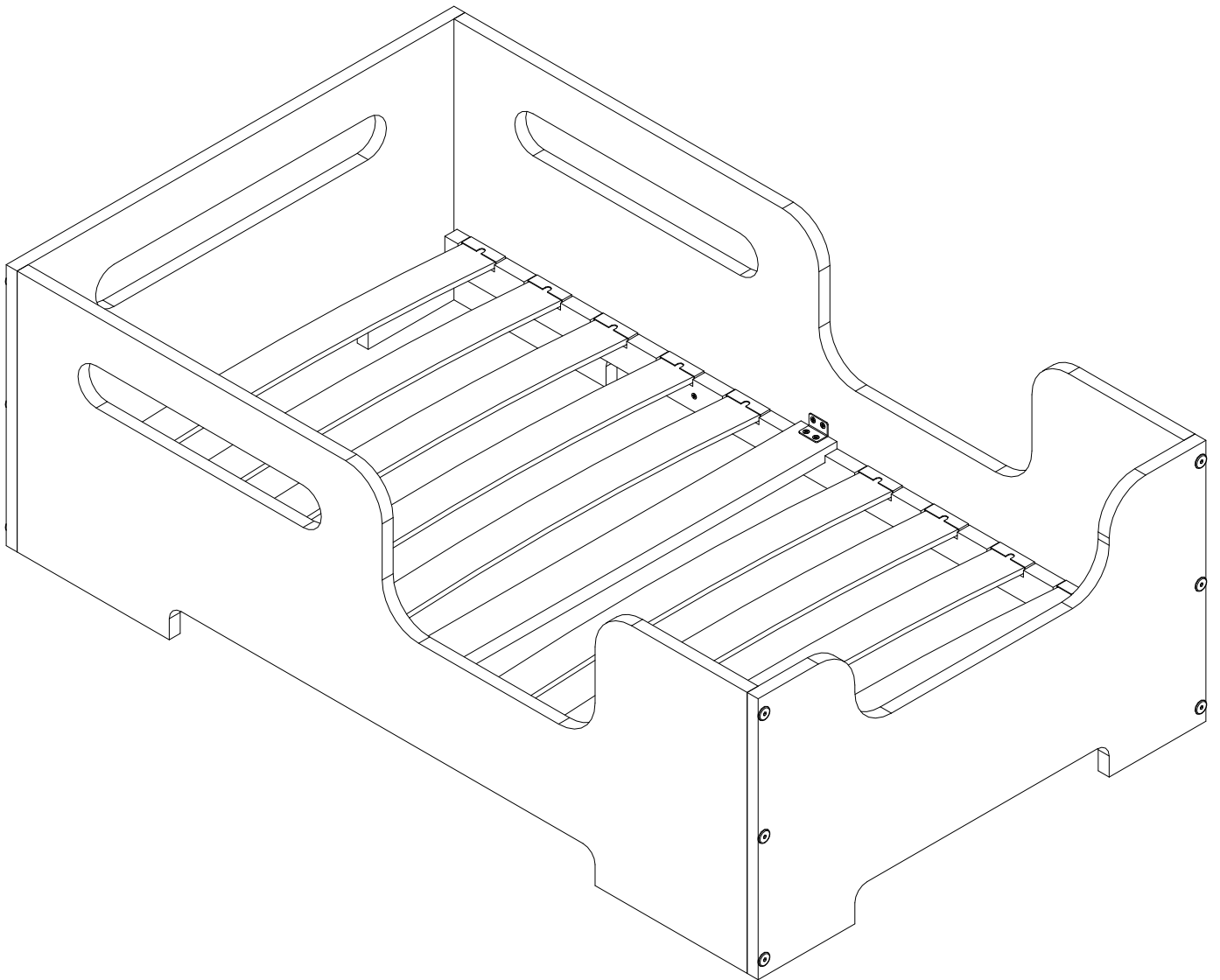

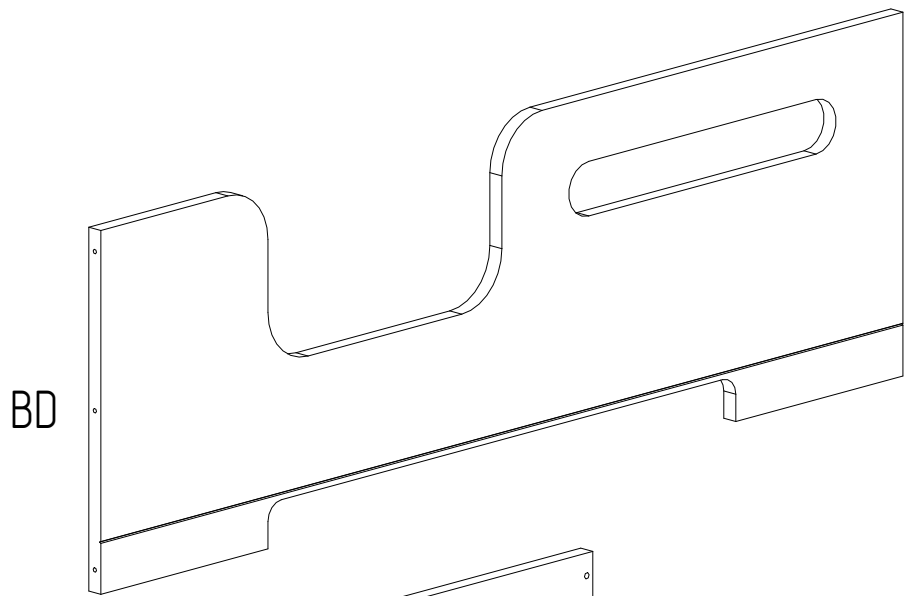

BD

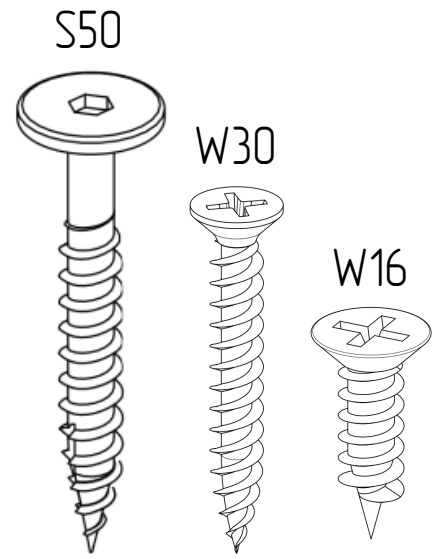

S50

W30

W16

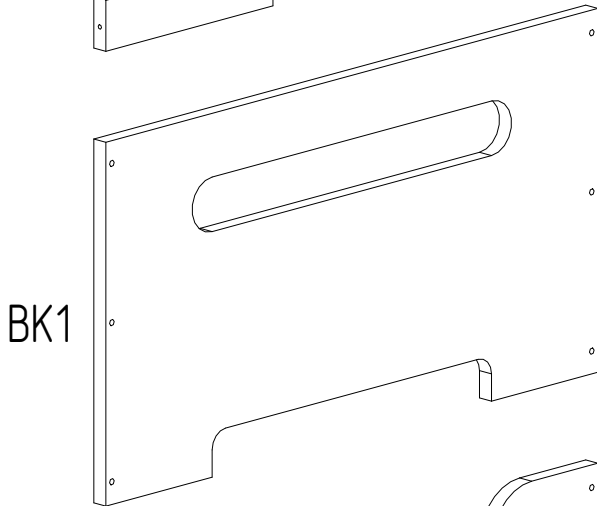

BK1

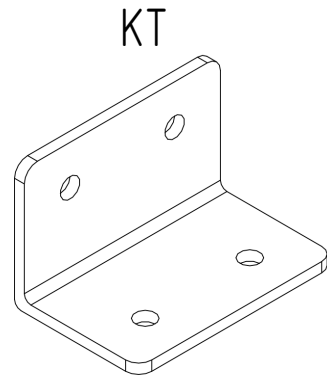

KT

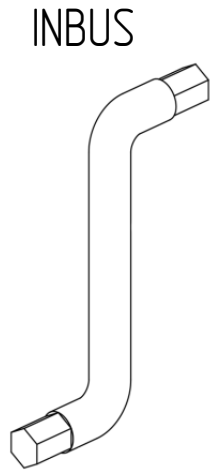

INBUS

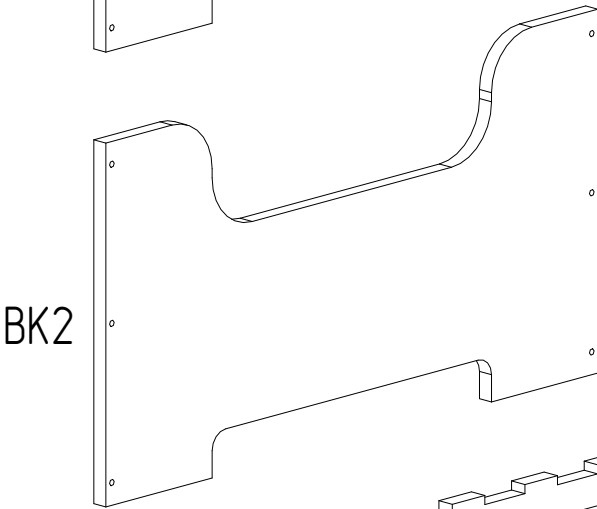

BK2

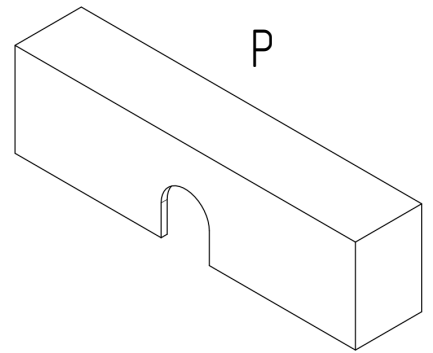

P

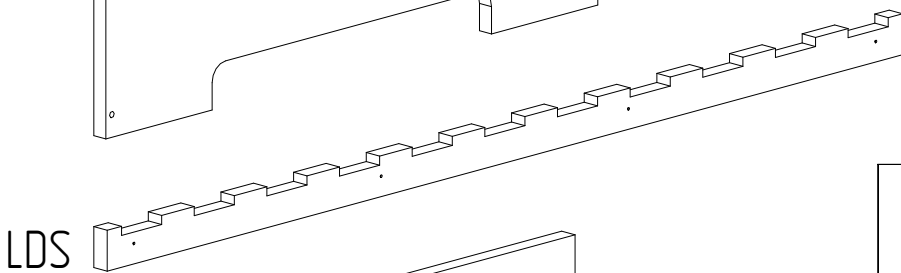

LDS

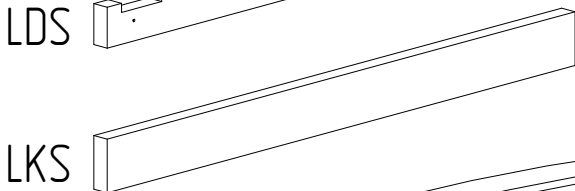

LKS

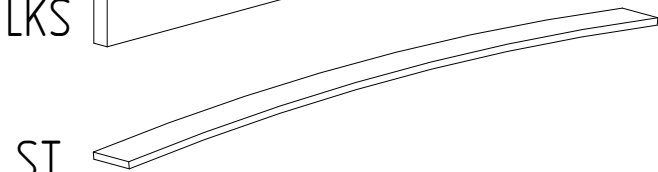

ST

DŁUGOŚĆ/LENGTH (cm)	ILOŚĆ/QUANTITY	
	ST	P
140	12	24
160	14	28
180	14	28
190	16	32
200	16	32

ELEMENT/PART	BD	BK1	BK2	LDS	LKS	S50	W30	W16	KT	INBUS
ILOŚĆ/QUANTITY	2	1	1	2	1	12	12	8	2	2

W30



BD x2

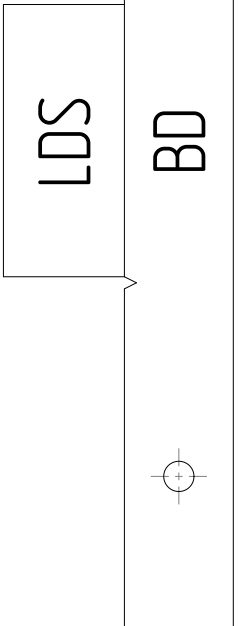
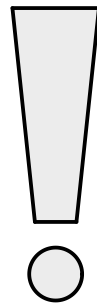
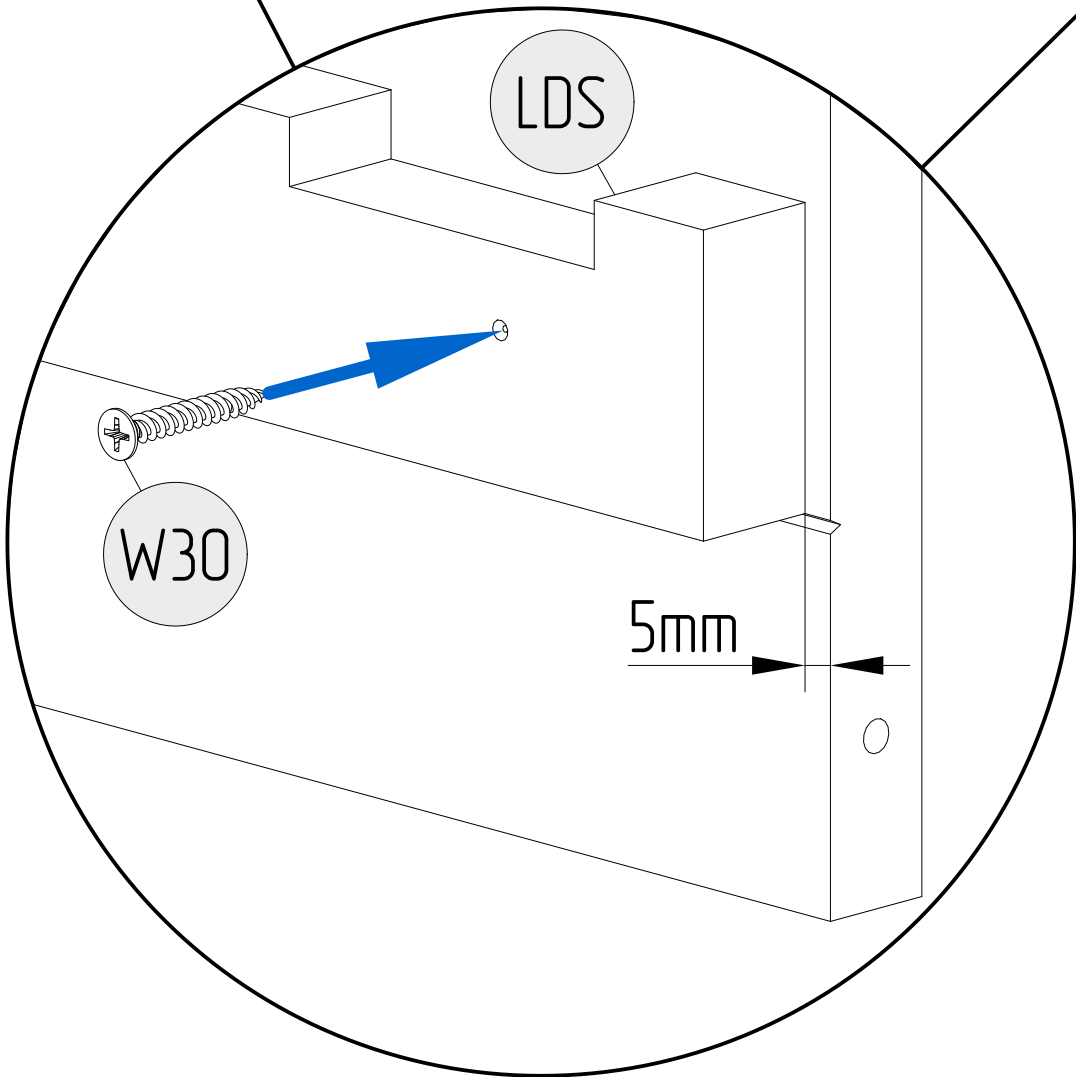
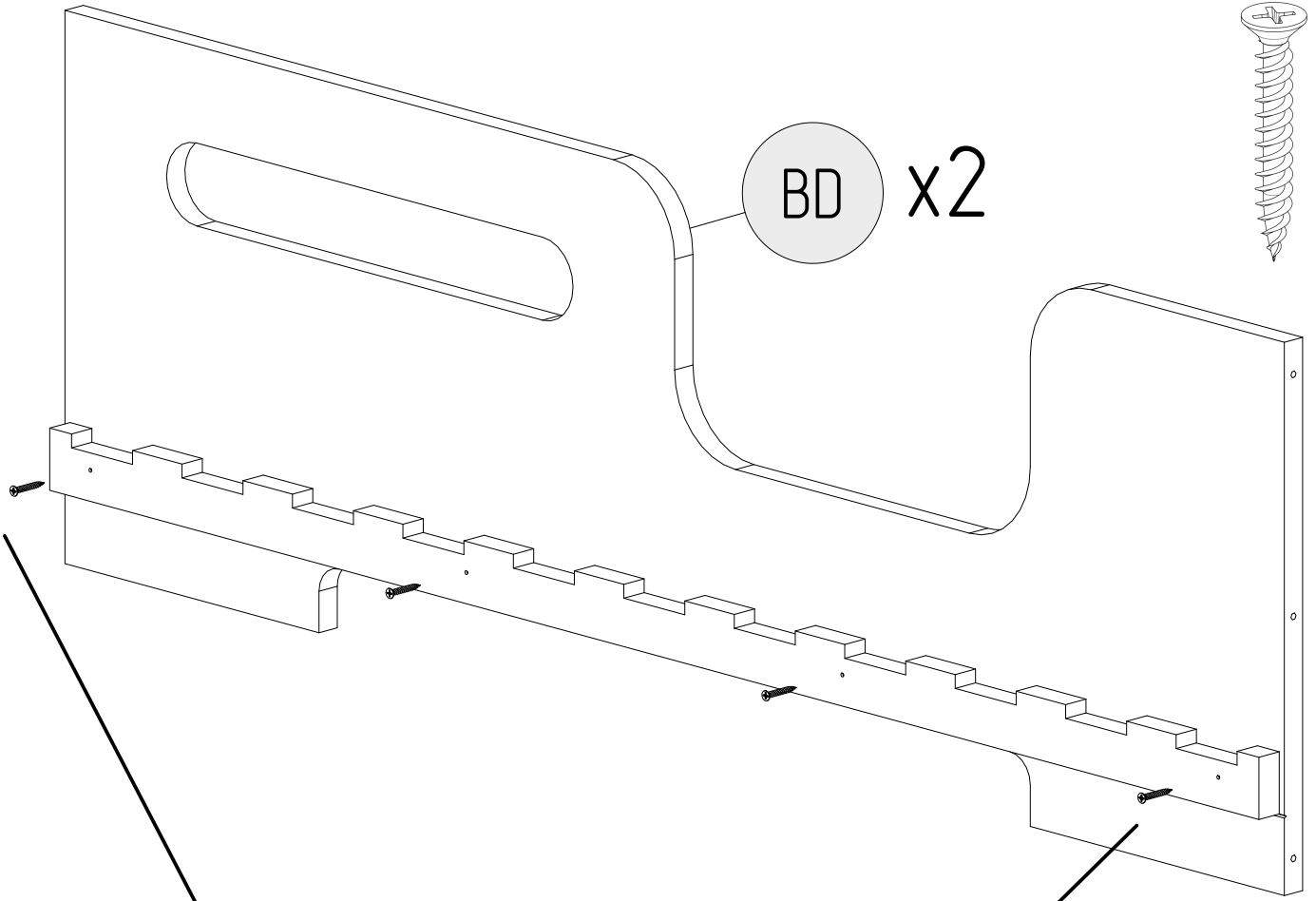

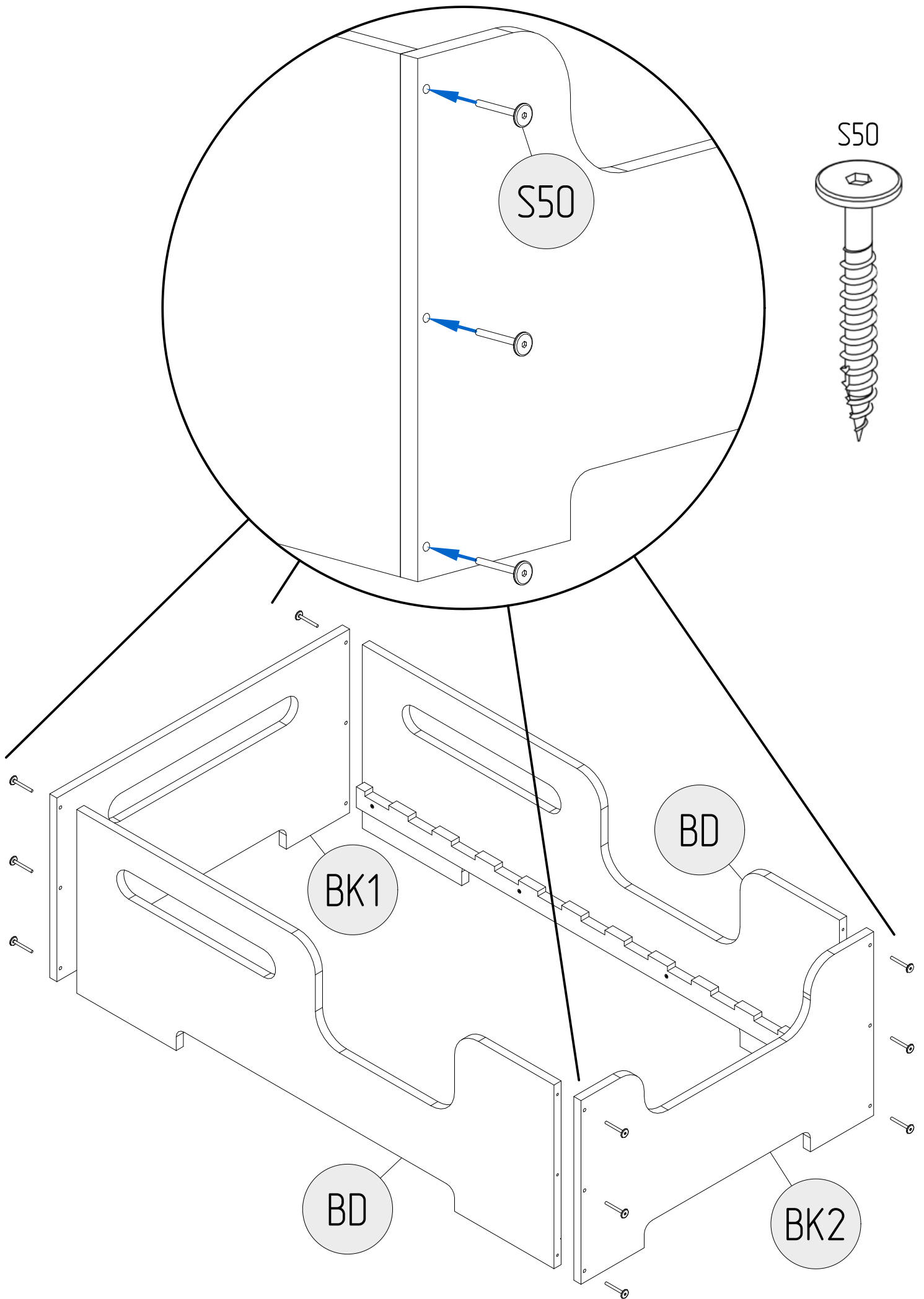

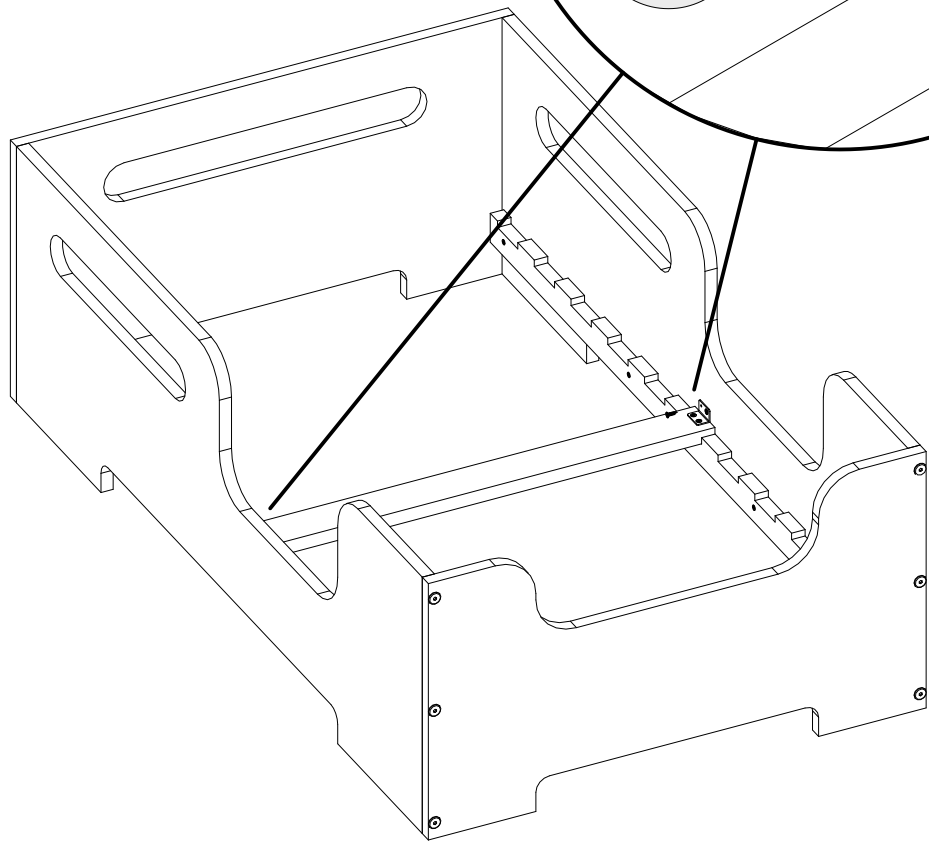
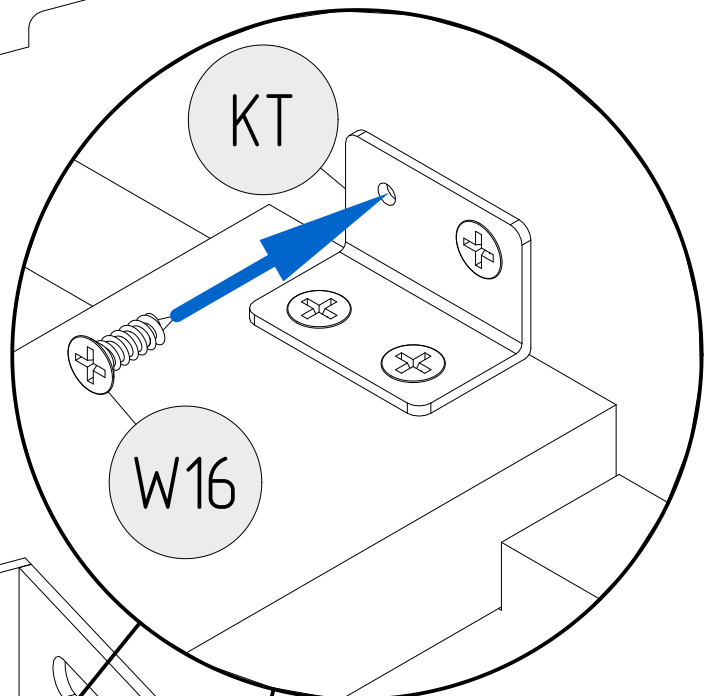
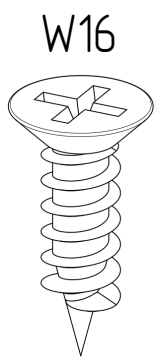
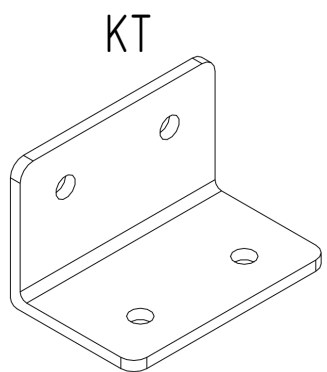
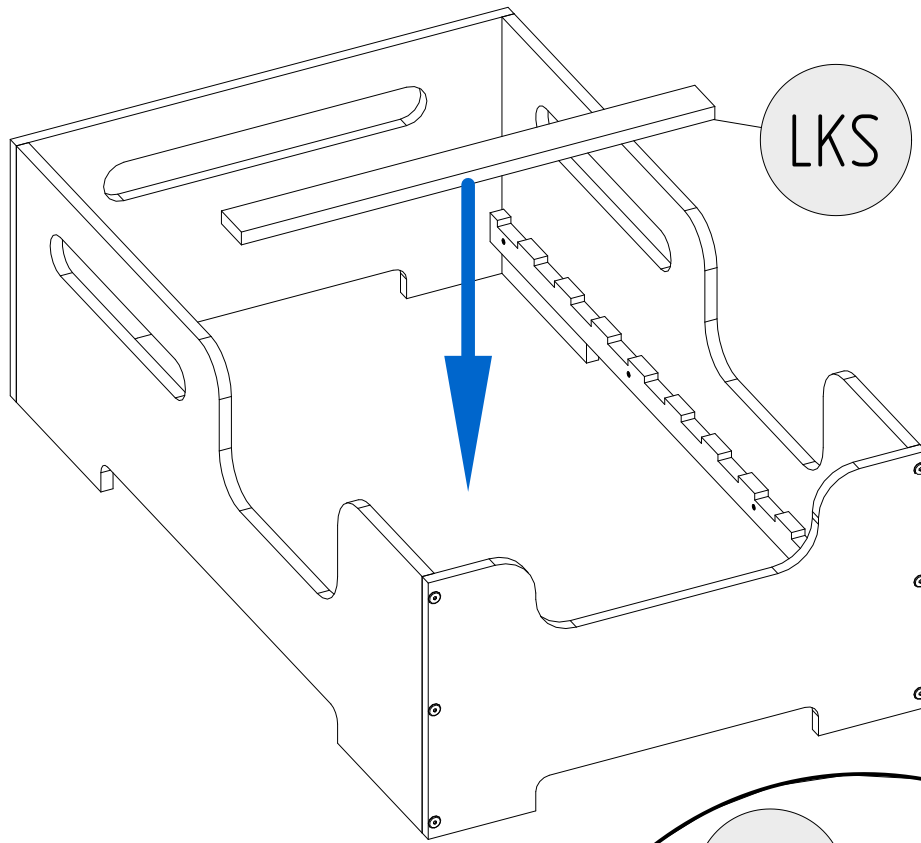

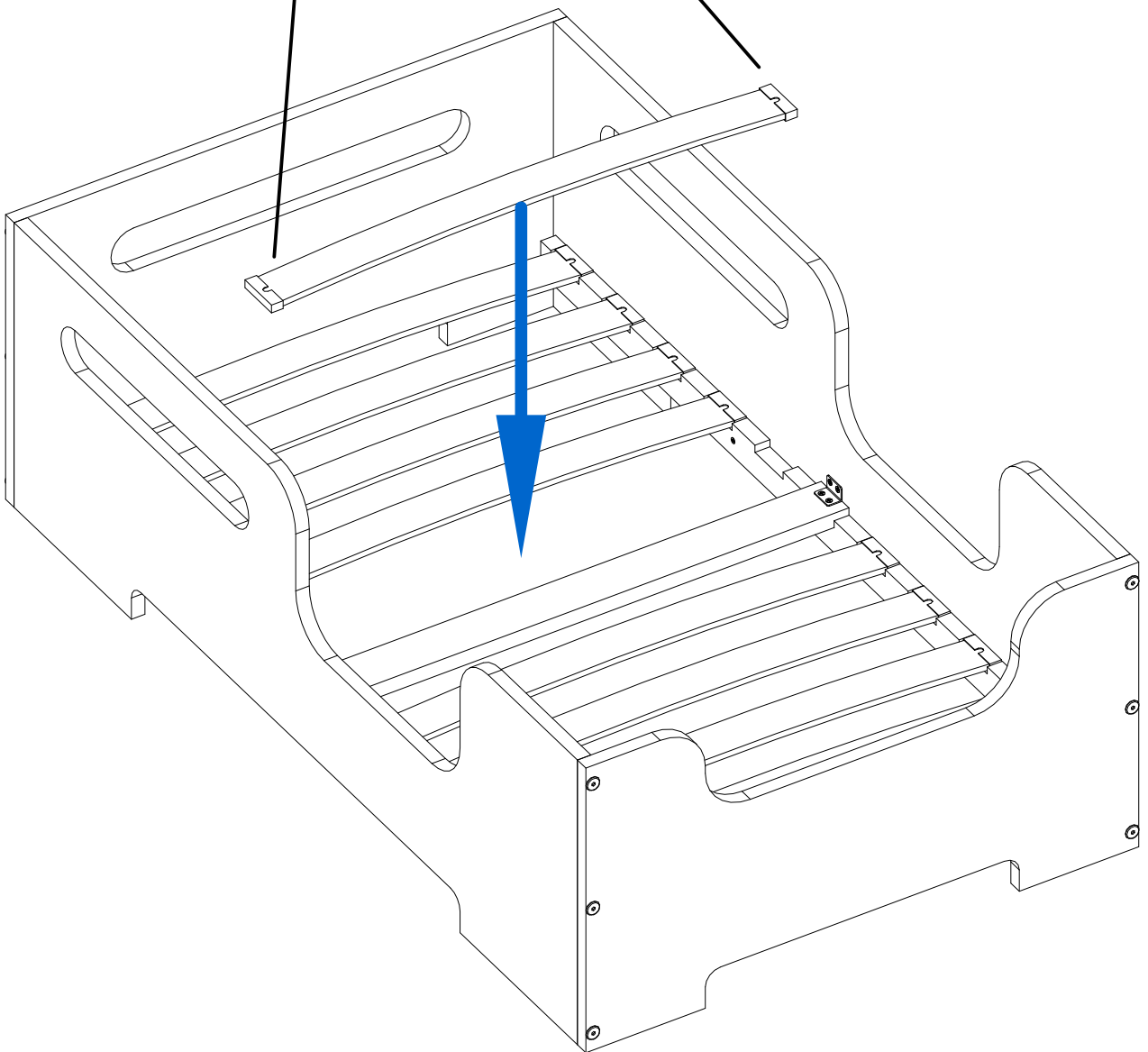
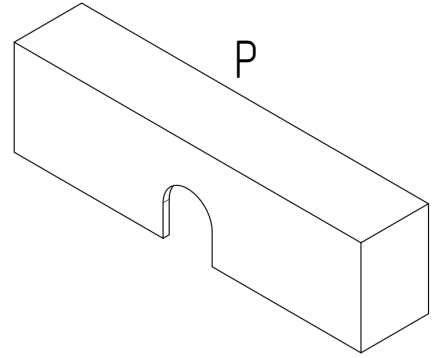
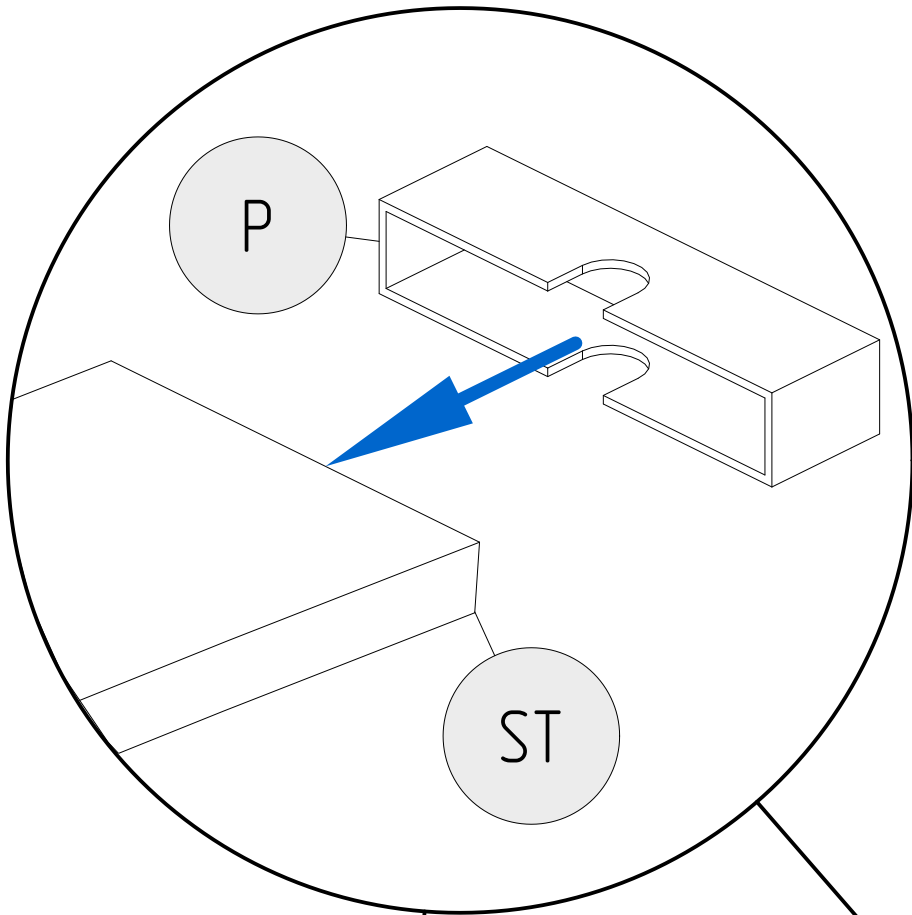

UWAGA / WARNING

- Używać tylko materacy o grubości 8-12 cm
- Nie skakać na łóżku
- Zakaz przebywania więcej niż jednej osoby na łóżku
- Maksymalne obciążenie konstrukcji wynosi 90 kg

Części drewniane i plastikowe należy czyścić za pomocą suchej szmatki oraz zwykłych, łagodnych środków do pielęgnacji i czyszczenia surowego drewna

- Use only mattress with thickness is 8-12 cm height
- Prohibit horseplay on or under bed(s)
- Prohibit more than one person on bunk
- The maximum load of the structure is 90 kg

Wooden and plastic should be cleaned with a dry cloth and ordinary, mild care and cleaning of raw wood